

I.

(- ')

1.1.

1.1.1

.1

.2

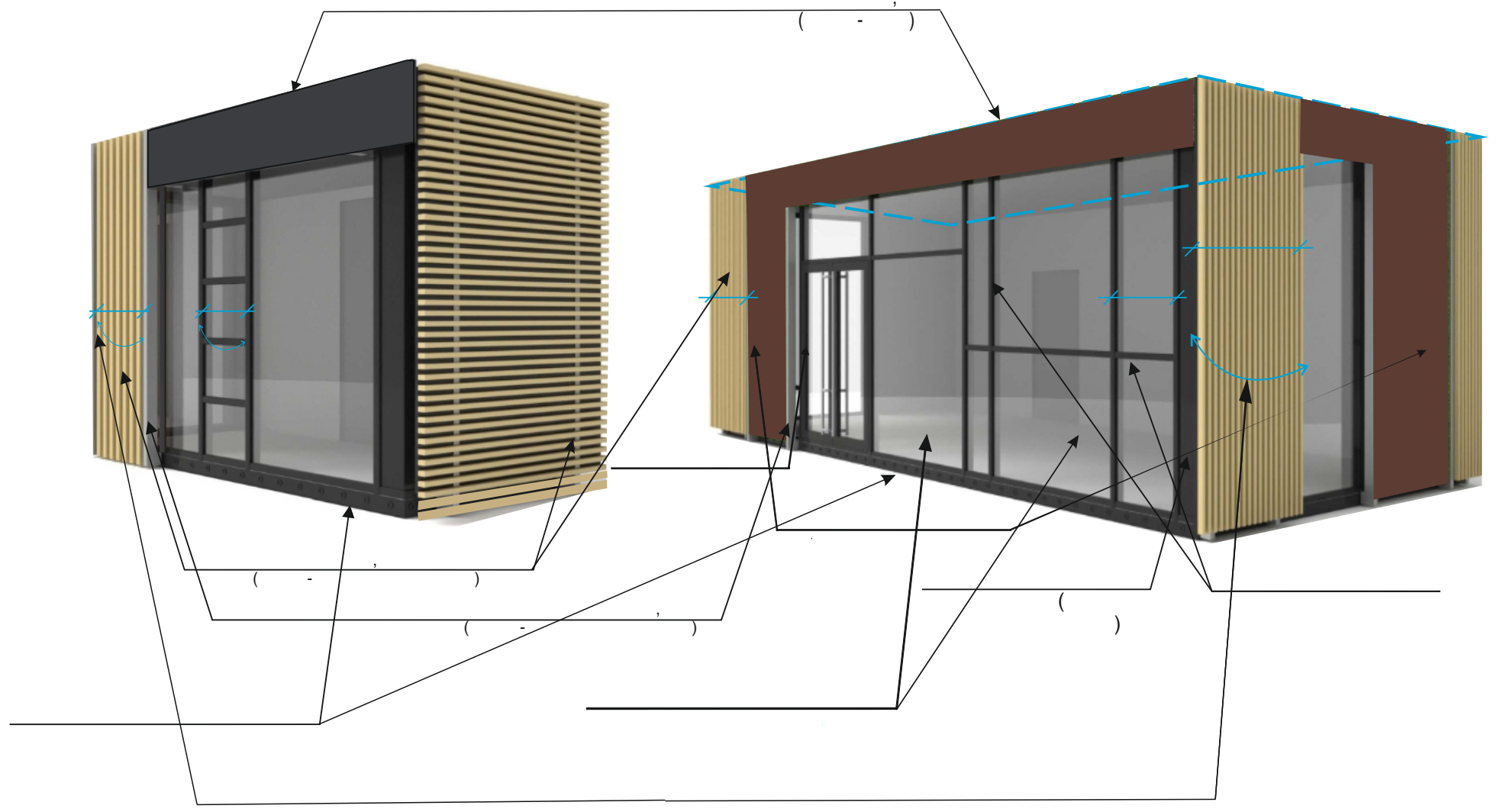

1.1.2

.3

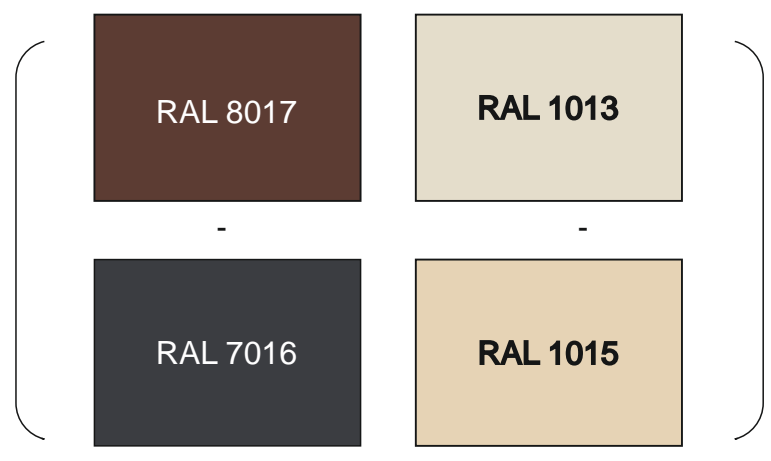

*

1.1.3

.4

.5

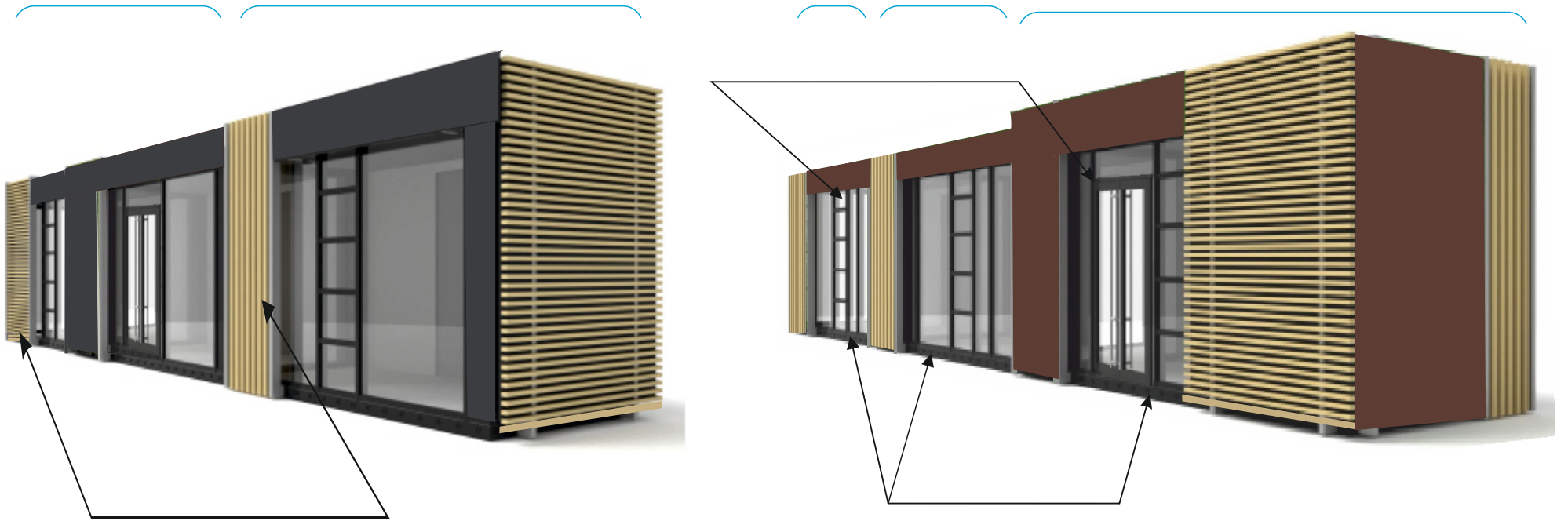

1.1.4

.6

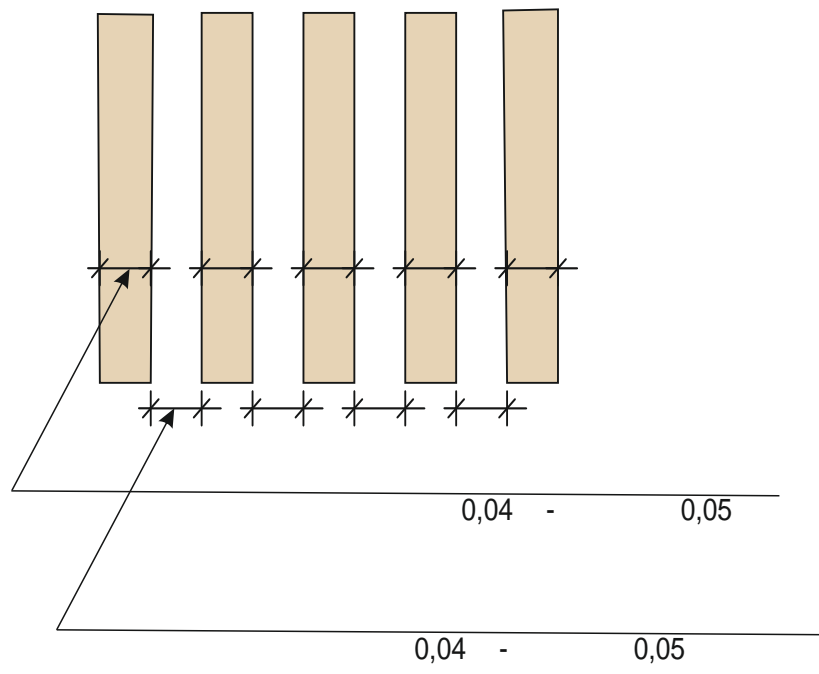

1.1.5

.7

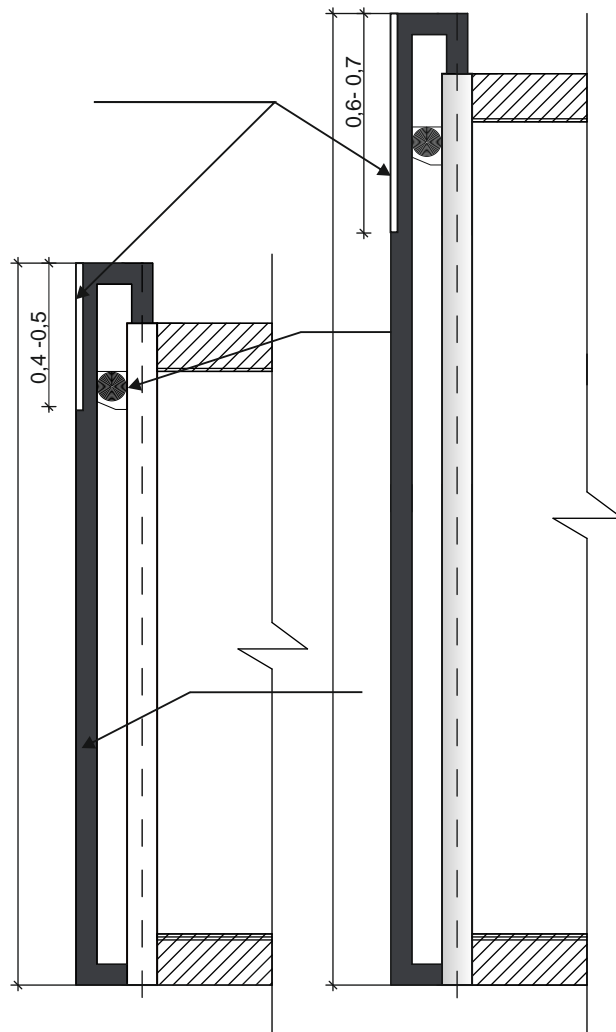

1.1.6

.8

.9

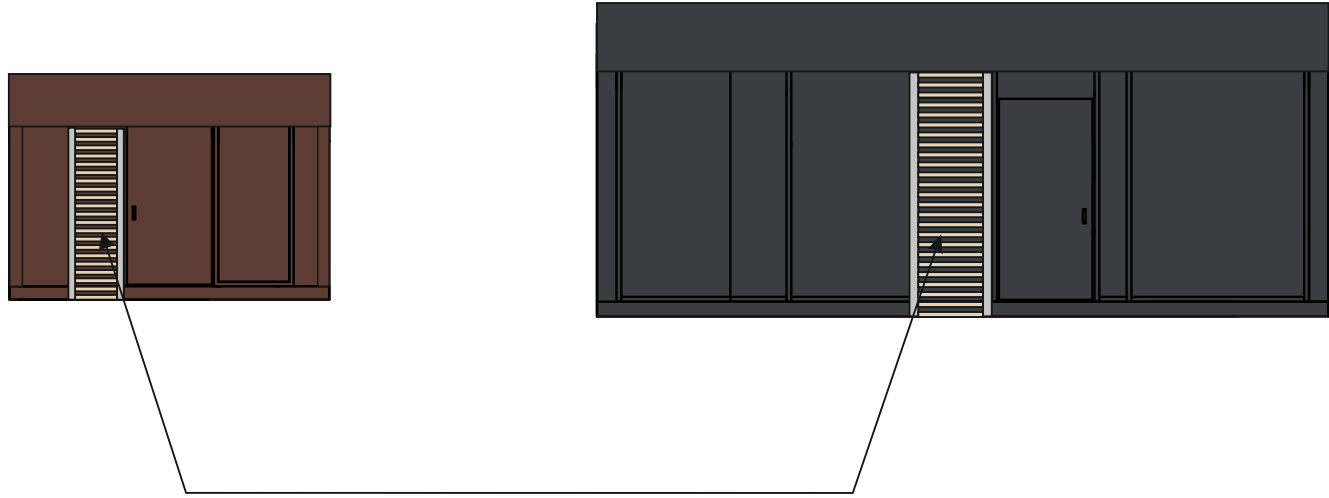

.10

.11

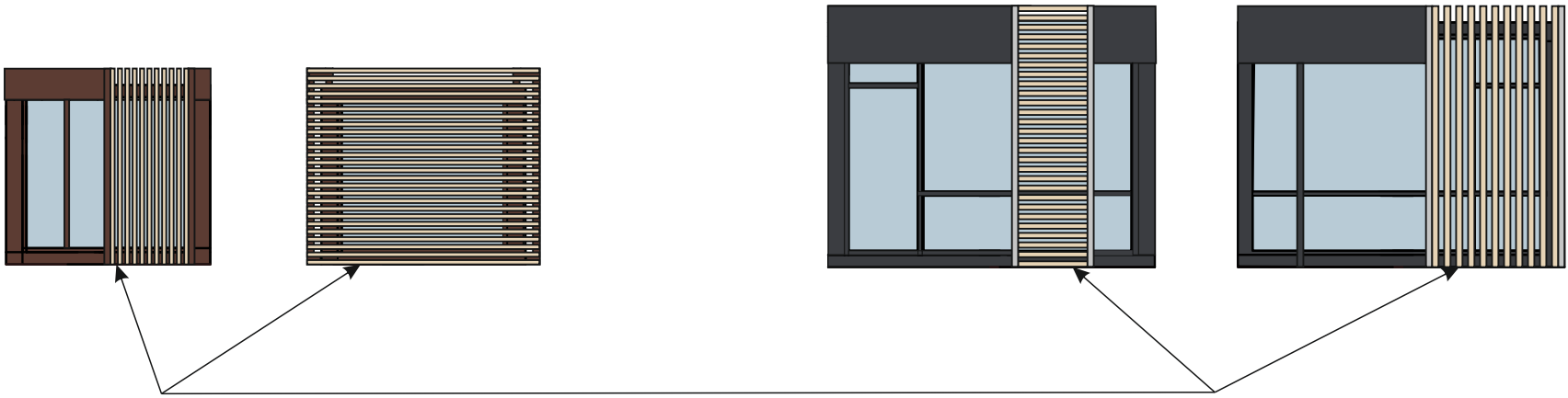

.12



1.2.

1.2.1

. 13

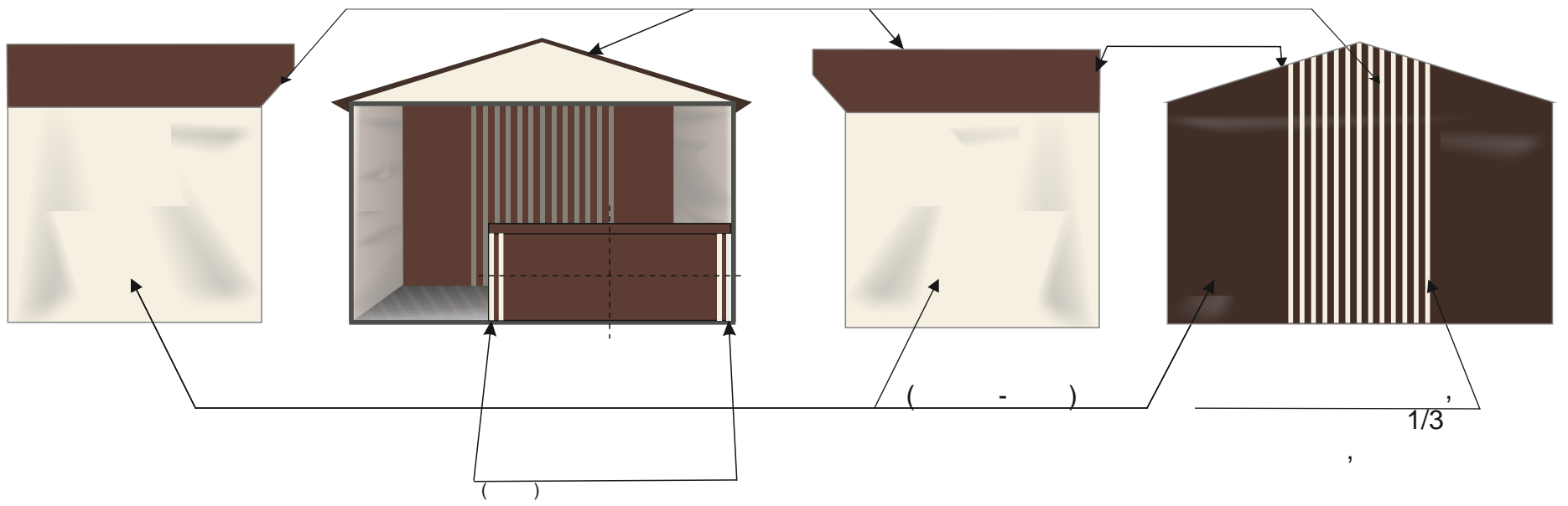

1.2.2

. 14

,
,
()

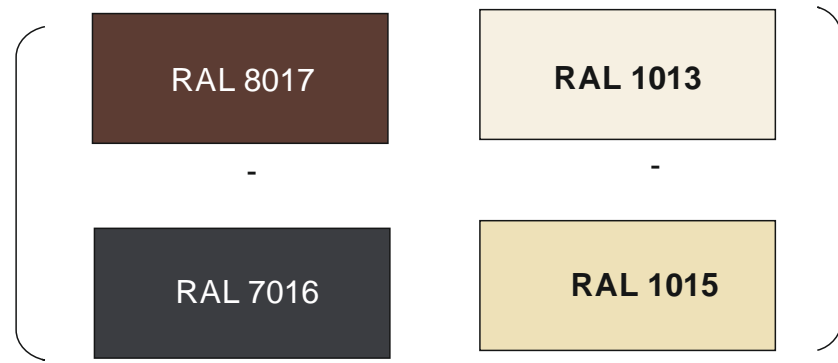

()

1.3.

()

(-)

1.3.1

.15

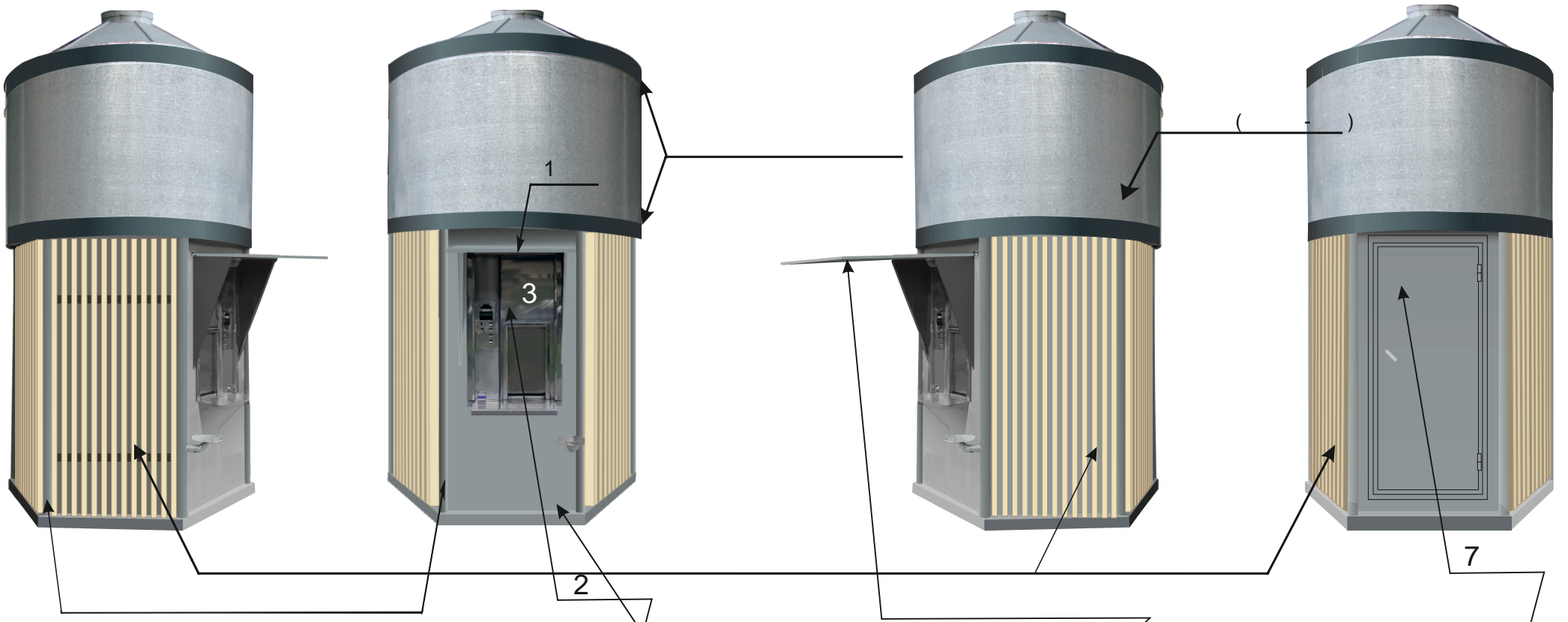

.16

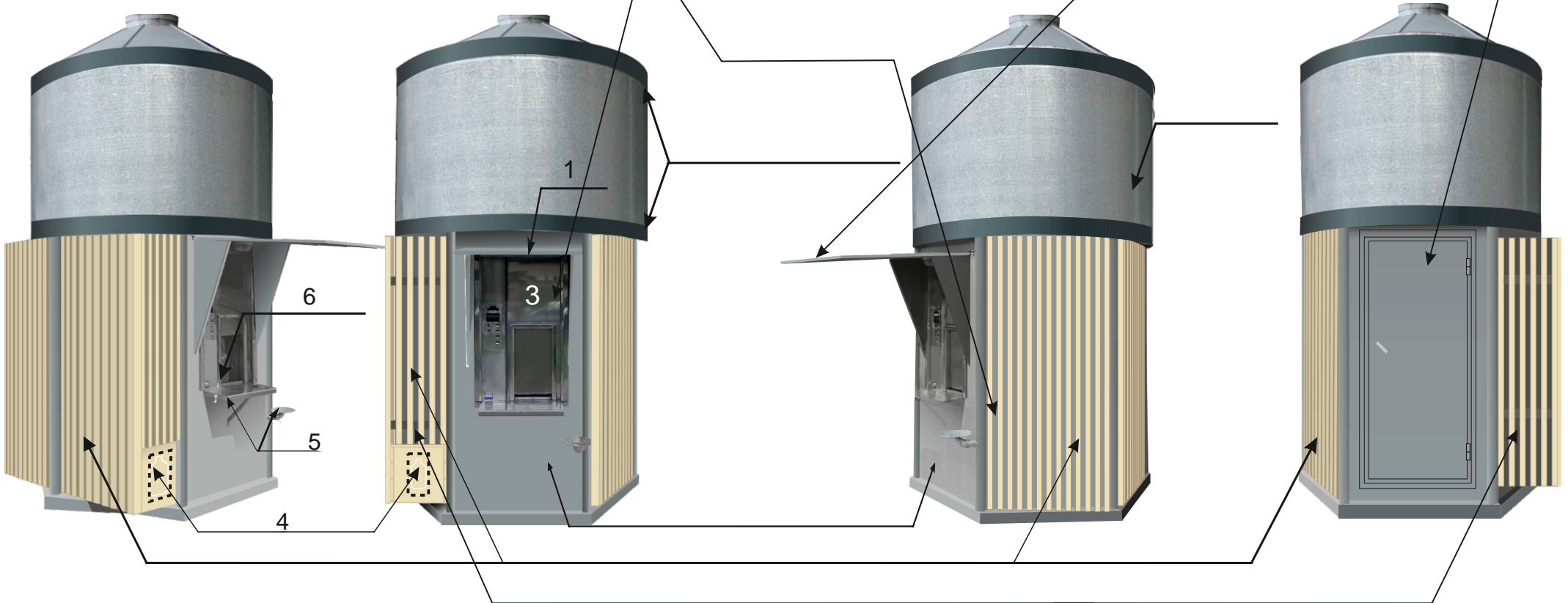

- 1)
- 2)
- 3)
- 4)
- 5)
- 6)
- 7)

1.3.2

.17

, , ,
, , *
,

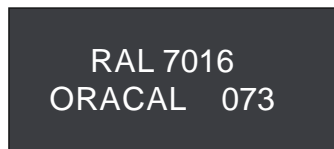
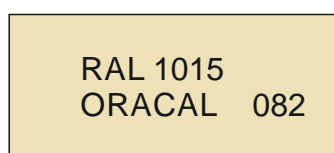
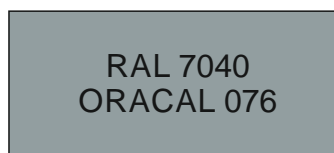

II.

2.1.

(-)

2.1.1

.18

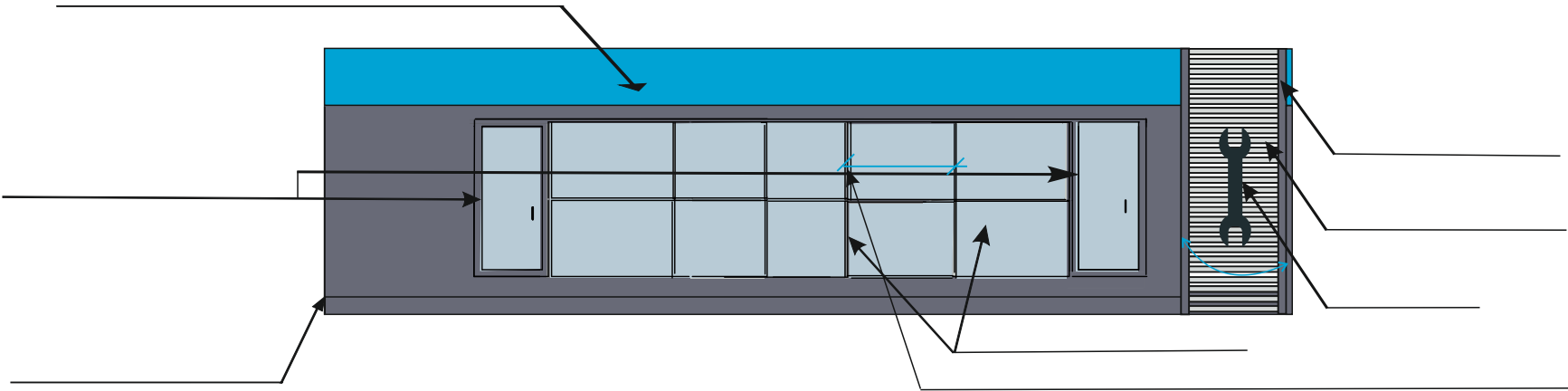

.19



.20

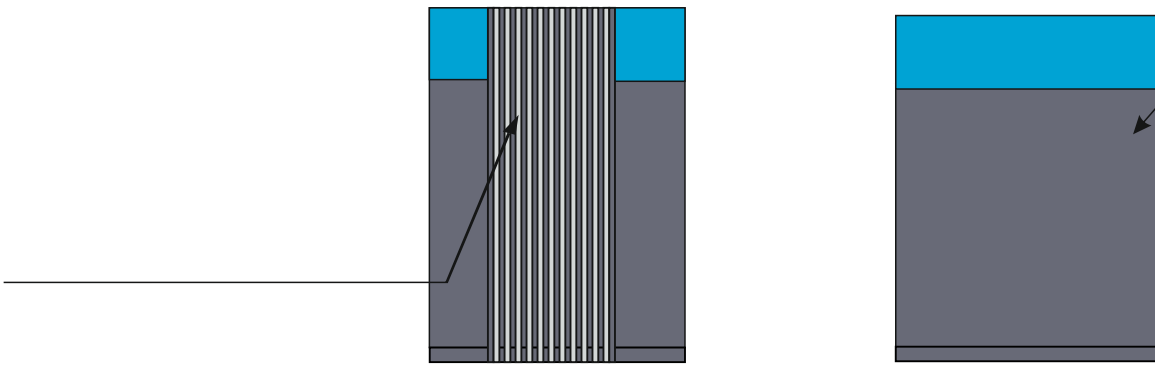

2.1.2

.21

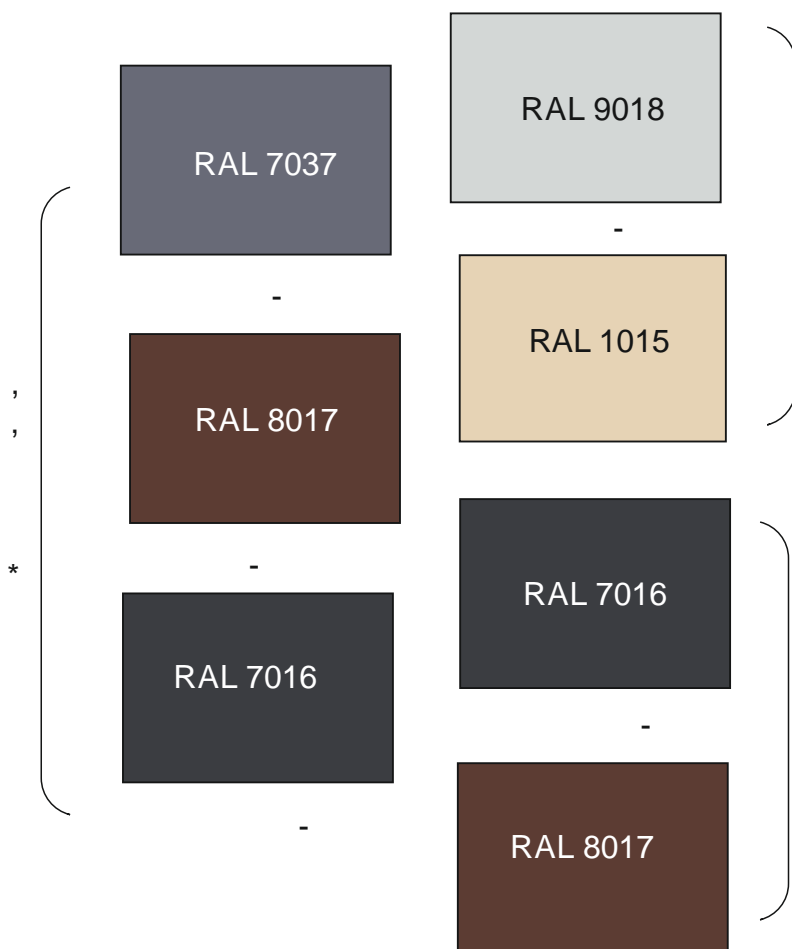

2.1.3

. 22

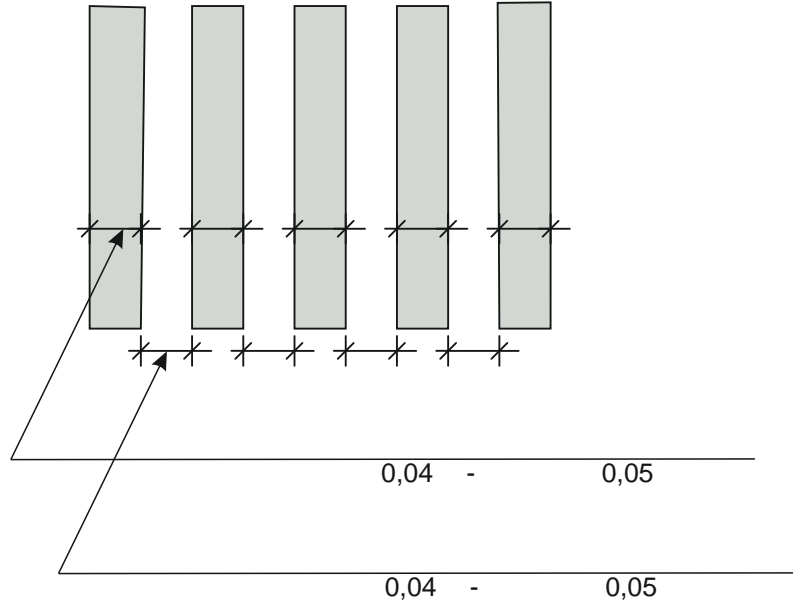

2.1.4

. 23

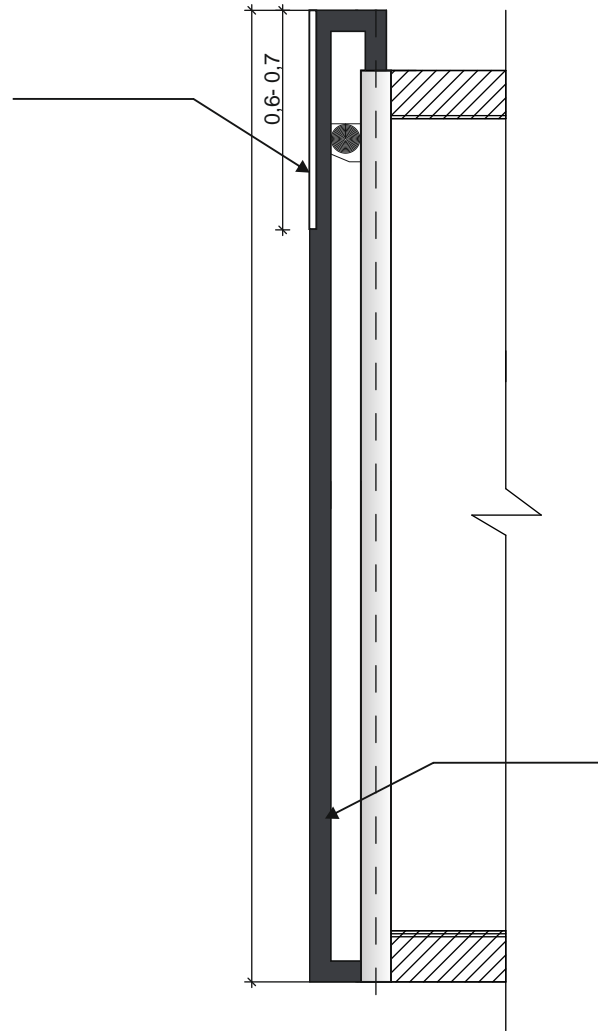

2.1.5

. 24

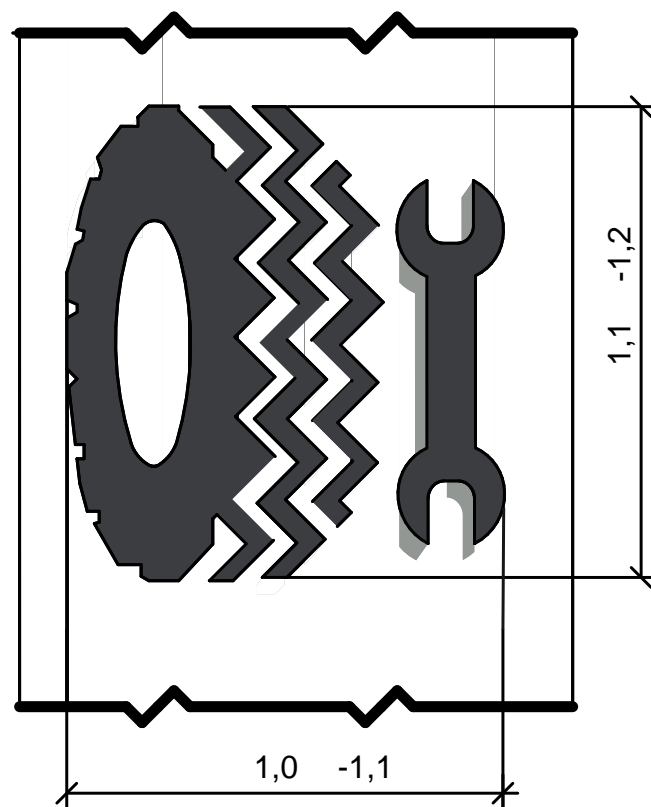

III.

. 25

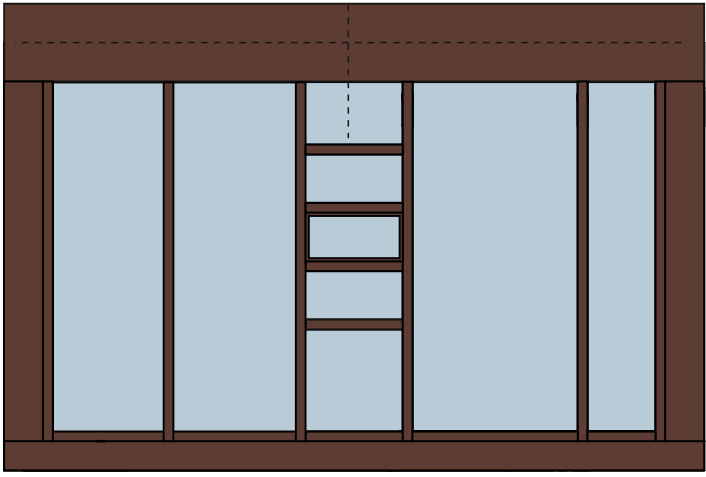

26

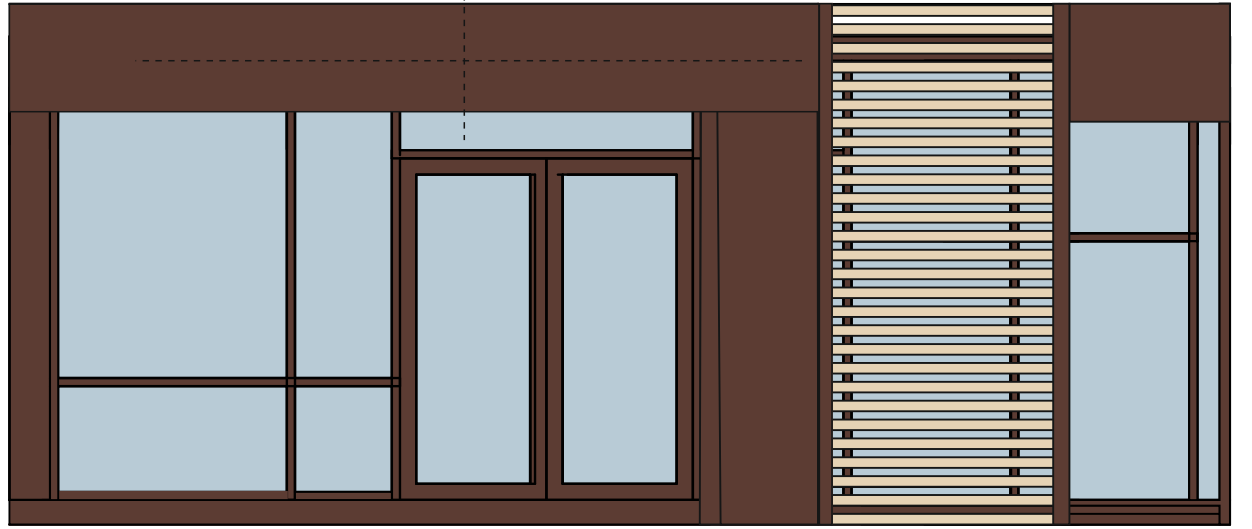

. 27

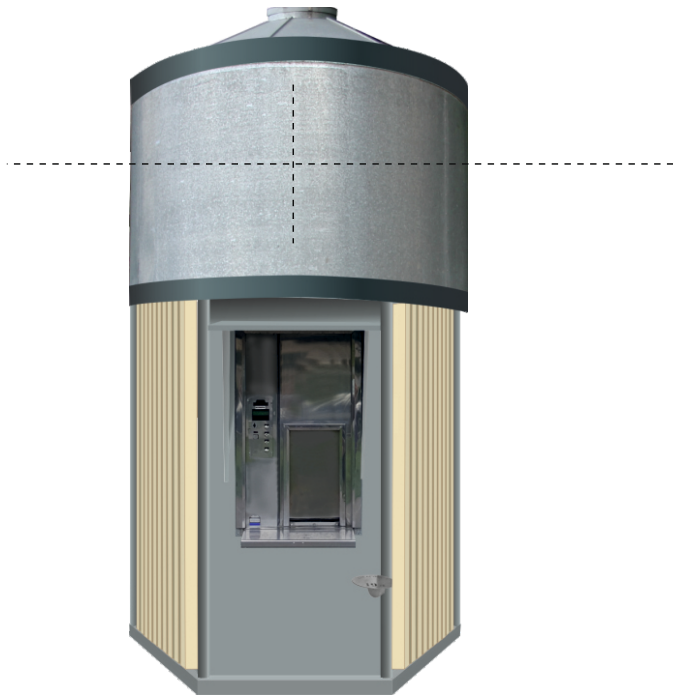

. 28

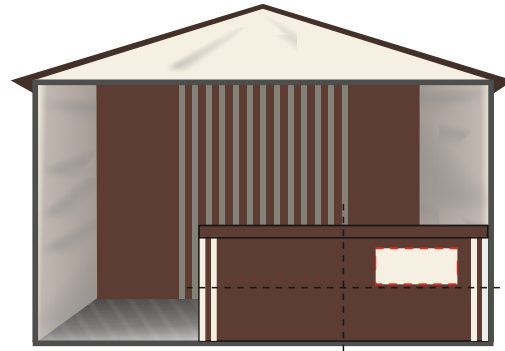

. 29

